

IRG4PH40UD2-EP

INSULATED GATE BIPOLAR TRANSISTOR WITH ULTRAFAST SOFT RECOVERY DIODE UltraFast CoPack IGBT

Features

- UltraFast IGBT optimized for high operating frequencies up to 200kHz in resonant mode
- IGBT co-packaged with HEXFRED™ ultrafast ultra-soft-recovery anti-parallel diode for use in resonant circuits
- Industry standard TO-247AD package with extended leads
- Lead-Free

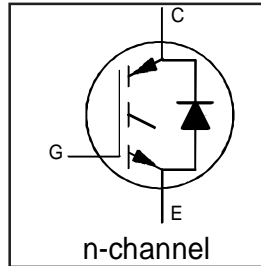

$V_{CES} = 1200V$
$V_{CE(on) typ.} = 2.43V$
@ $V_{GE} = 15V, I_C = 21A$

Benefits

- Higher switching frequency capability than competitive IGBTs
- Highest efficiency available
- HEXFRED diodes optimized for performance with IGBTs. Minimized recovery characteristics require less / no snubbing

Applications

- Induction cooking systems
- Microwave Ovens
- Resonant Circuits

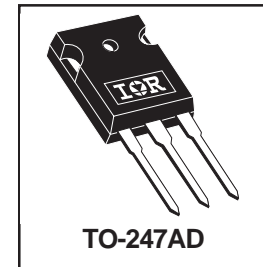

Absolute Maximum Ratings

	Parameter	Max.	Units
V_{CES}	Collector-to-Emitter Voltage	1200	V
$I_C @ T_C = 25^\circ C$	Continuous Collector Current	41	A
$I_C @ T_C = 100^\circ C$	Continuous Collector Current	21	
I_{CM}	Pulse Collector Current ①	82	
I_{LM}	Clamped Inductive Load current ②	82	
$I_F @ T_C = 100^\circ C$	Diode Continuous Forward Current	10	
I_{FM}	Diode Maximum Forward Current	40	
V_{GE}	Gate-to-Emitter Voltage	± 20	V
$P_D @ T_C = 25^\circ C$	Maximum Power Dissipation	160	W
$P_D @ T_C = 100^\circ C$	Maximum Power Dissipation	65	
T_J	Operating Junction and	-55 to +150	$^\circ C$
T_{STG}	Storage Temperature Range		
	Storage Temperature Range, for 10 sec.		
	Mounting Torque, 6-32 or M3 screw	10 lbf•in (1.1N•m)	

Thermal / Mechanical Characteristics

	Parameter	Min.	Typ.	Max.	Units
$R_{\theta JC}$	Junction-to-Case- IGBT	—	—	0.77	$^\circ C/W$
$R_{\theta JC}$	Junction-to-Case- Diode	—	—	2.5	
$R_{\theta CS}$	Case-to-Sink, flat, greased surface	—	0.24	—	
$R_{\theta JA}$	Junction-to-Ambient, typical socket mount	—	—	40	
Wt	Weight	—	6 (0.21)	—	g (oz.)

IRG4PH40UD2-EP

International
IRF Rectifier

Electrical Characteristics @ T_J = 25°C (unless otherwise specified)

Parameter	Min.	Typ.	Max.	Units	Conditions	
V _{(BR)CES}	1200	—	—	V	V _{GE} = 0V, I _C = 250μA	
V _{(BR)ECS}	18	—	—	V	V _{GE} = 0V, I _C = 1.0A	
ΔV _{(BR)CES} /ΔT _J	—	0.43	—	V/°C	V _{GE} = 0V, I _C = 1mA	
V _{CE(on)}	Collector-to-Emitter Saturation Voltage	—	2.43	3.1	V	I _C = 21A, V _{GE} = 15V
		—	2.97	—		I _C = 41A, See Fig.2, 5
		—	2.47	—		I _C = 21A, T _J = 150°C
V _{GE(th)}	3.0	—	6.0		V _{CE} = V _{GE} , I _C = 250μA	
ΔV _{GE(th)} /ΔT _J	—	-11	—	mV/°C	V _{CE} = V _{GE} , I _C = 250μA	
g _f	16	24	—	S	V _{CE} = 100V, I _C = 21A	
I _{CES}	Zero Gate Voltage Collector Current	—	—	250	μA	V _{GE} = 0V, V _{CE} = 1200V
		—	—	5000		V _{GE} = 0V, V _{CE} = 1200V, T _J = 150°C
V _{FM}	Diode Forward Voltage Drop	—	3.4	3.8	V	I _F = 10A, See Fig.13
		—	3.3	3.7		I _F = 10A, T _J = 150°C
I _{GES}	Gate-to-Emitter Leakage Current	—	—	±100	nA	V _{GE} = ±20V

Switching Characteristics @ T_J = 25°C (unless otherwise specified)

Parameter	Min.	Typ.	Max.	Units	Conditions	
Q _g	—	100	150		I _C = 21A	
Q _{ge}	—	18	24	nC	V _{CC} = 400V, See Fig.8	
Q _{gc}	—	34	50		V _{GE} = 15V	
t _{d(on)}	—	22	—	ns	I _C = 21A, V _{CC} = 800V V _{GE} = 15V, R _G = 10Ω Energy losses include "tail" and diode reverse recovery.	
t _r	—	26	—			
t _{d(off)}	—	100	140			
t _f	—	200	300			
E _{on}	—	1950	—	μJ	See Fig. 9, 10, 11, 18	
E _{off}	—	1710	—			
E _{tot}	—	3660	4490			
t _{d(on)}	—	21	—	ns	T _J = 150°C, See Fig. 9, 10, 11, 18 I _C = 21A, V _{CC} = 800V V _{GE} = 15V, R _G = 10Ω Energy losses include "tail" and diode reverse recovery.	
t _r	—	25	—			
t _{d(off)}	—	220	—			
t _f	—	380	—			
E _{TS}	—	6220	—	μJ		
L _E	—	13	—	nH	Measured 5mm from package	
C _{ies}	—	2100	—	pF	V _{GE} = 0V V _{CC} = 30V, See Fig.7 f = 1.0MHz	
C _{oes}	—	99	—			
C _{res}	—	12	—			
t _{rr}	Diode Reverse Recovery Time	—	50	76	ns	T _J =25°C, See Fig
		—	72	110		T _J =125°C, 14
I _{rr}	Diode Peak Reverse Recovery Current	—	4.4	7.0	A	T _J =25°C, See Fig
		—	5.9	8.8		T _J =125°C, 15
Q _{rr}	Diode Reverse Recovery Charge	—	130	200	nC	T _J =25°C, See Fig
		—	250	380		T _J =125°C, 16
di _(rec) /dt	Diode Peak Rate of Fall of Recovery During t _b	—	210	—	A/μs	T _J =25°C, See Fig
		—	180	—		T _J =125°C, 17

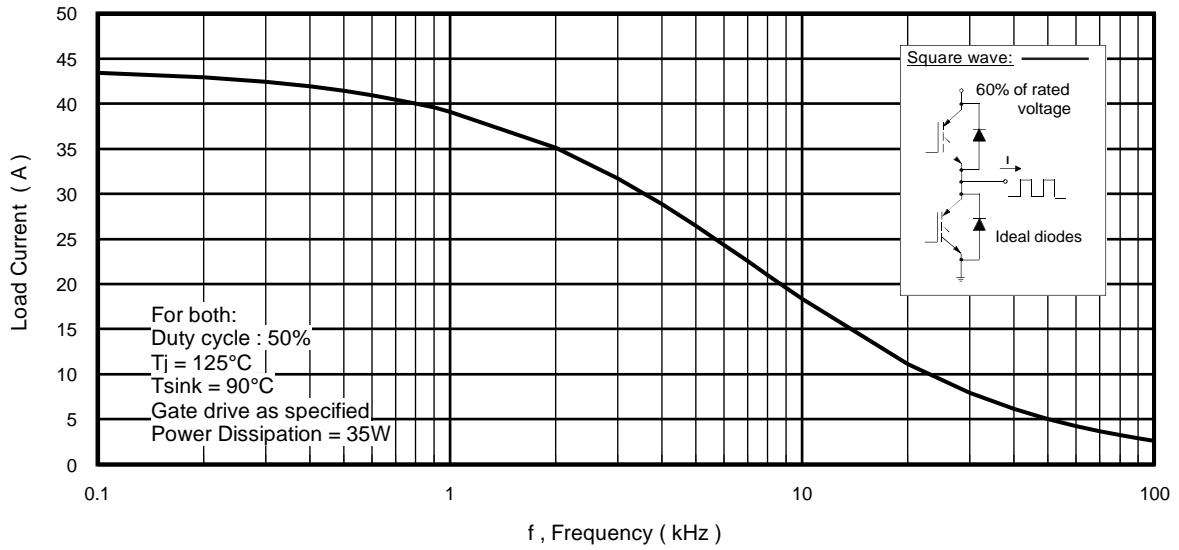

Fig. 1 - Typical Load Current vs. Frequency
 (Load Current = I_{RMS} of fundamental)

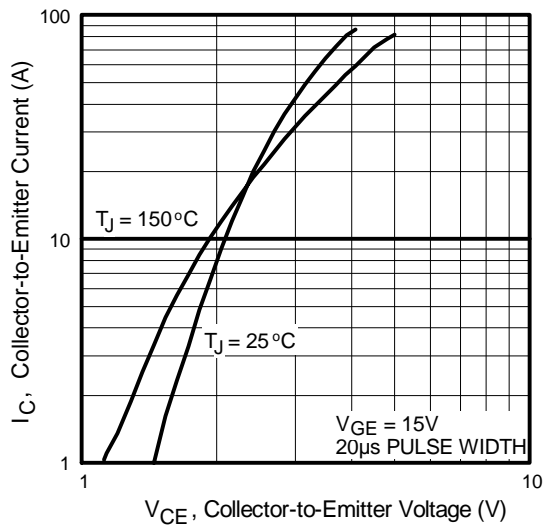

Fig. 2 - Typical Output Characteristics
www.irf.com

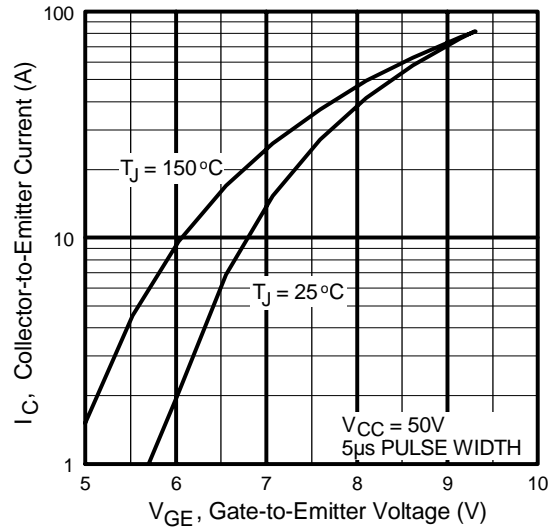

Fig. 3 - Typical Transfer Characteristics

IRG4PH40UD2-EP

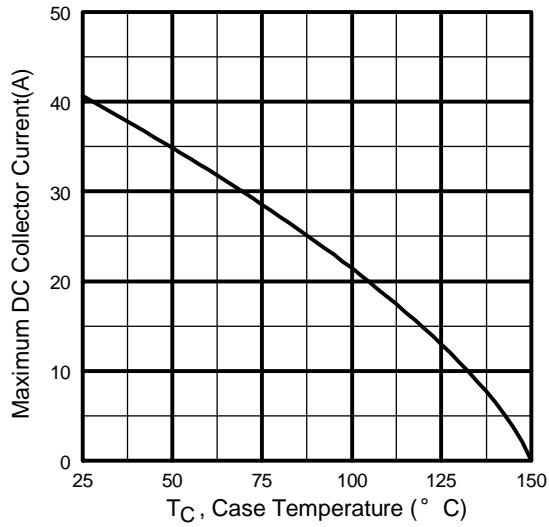

Fig. 4 - Maximum Collector Current vs. Case Temperature

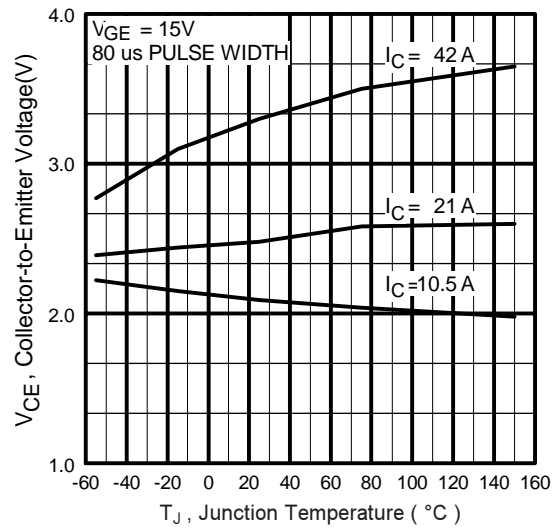

Fig. 5 - Typical Collector-to-Emitter Voltage vs. Junction Temperature

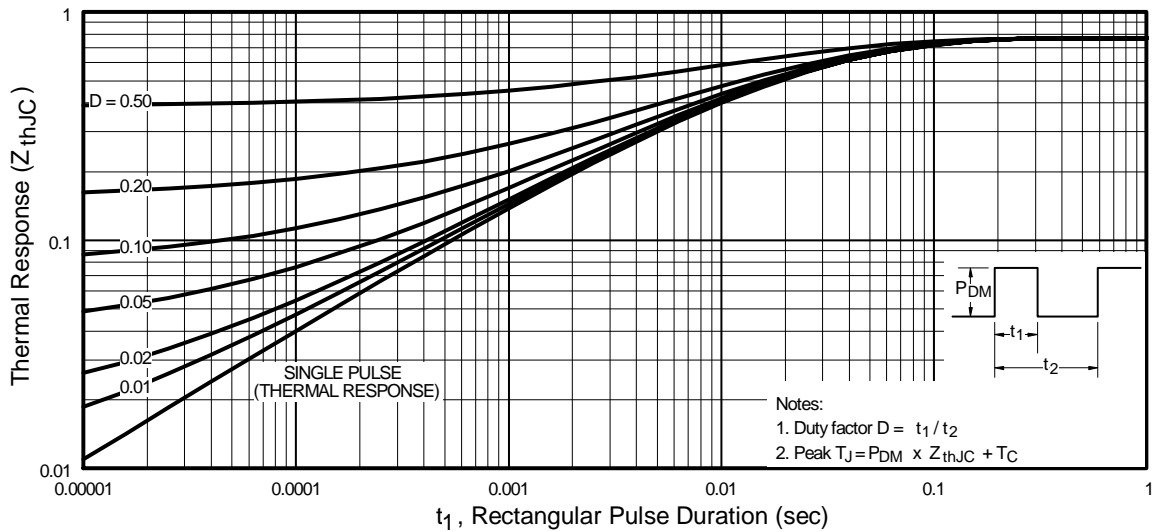

Fig. 6 - Maximum Effective Transient Thermal Impedance, Junction-to-Case

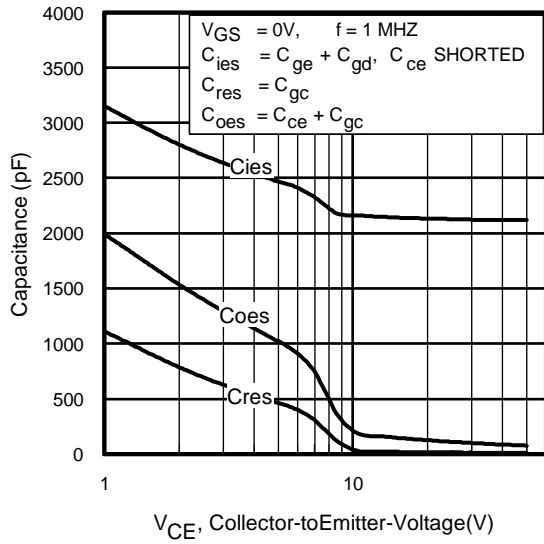

Fig. 7 - Typical Capacitance vs. Collector-to-Emitter Voltage

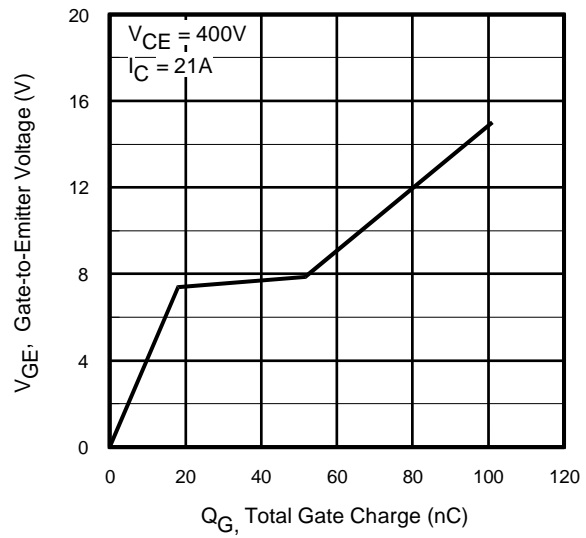

Fig. 8 - Typical Gate Charge vs. Gate-to-Emitter Voltage

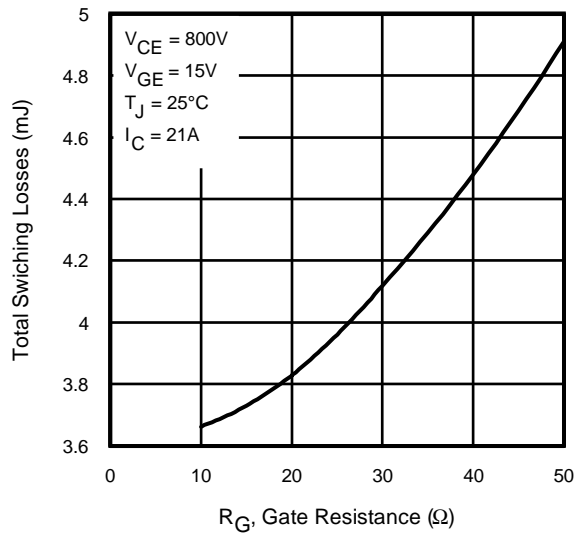

Fig. 9 - Typical Switching Losses vs. Gate Resistance

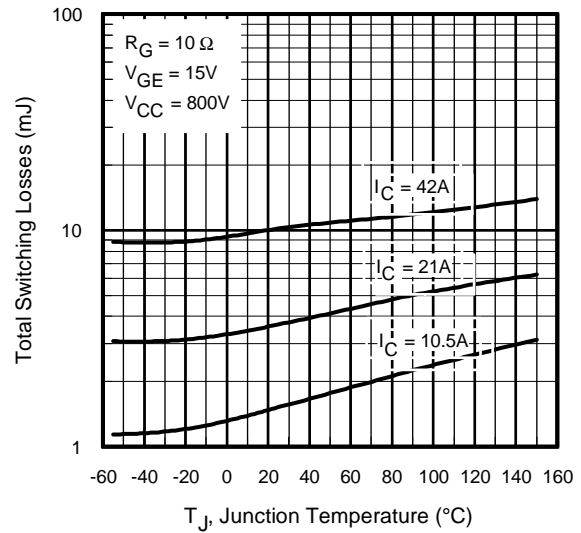

Fig. 10 - Typical Switching Losses vs. Junction Temperature

IRG4PH40UD2-EP

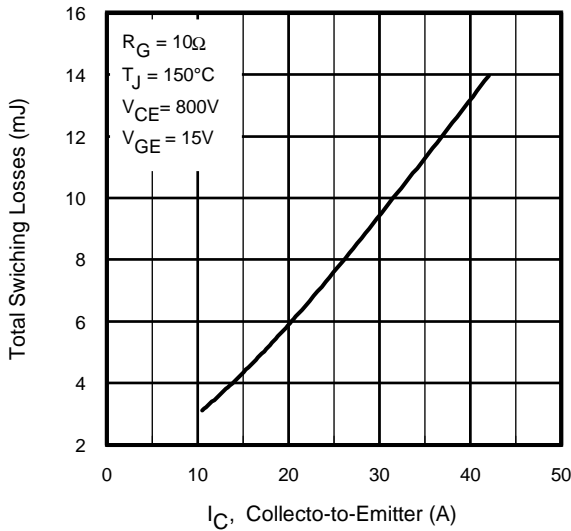

Fig. 11 - Typical Switching Losses vs. Collector-to-Emitter Current

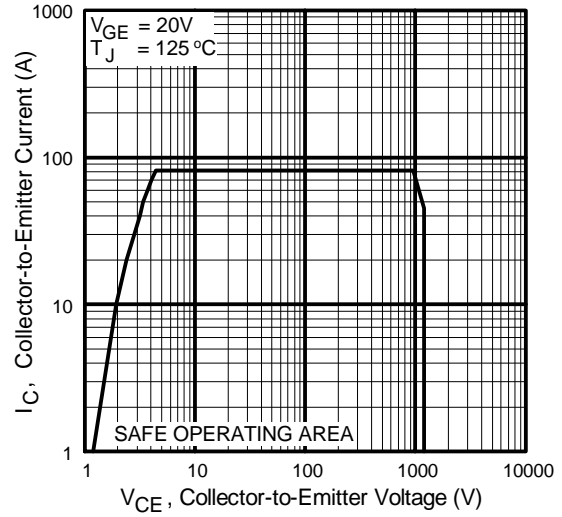

Fig. 12 - Turn-Off SOA

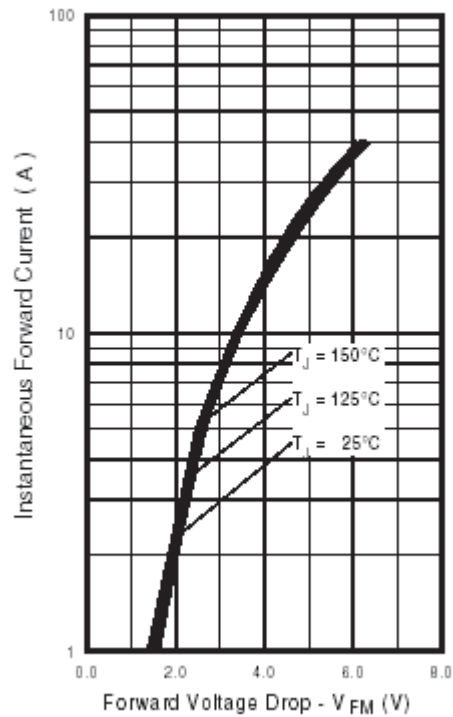

Fig. 13 - Maximum Forward Voltage Drop vs. Instantaneous Forward Current

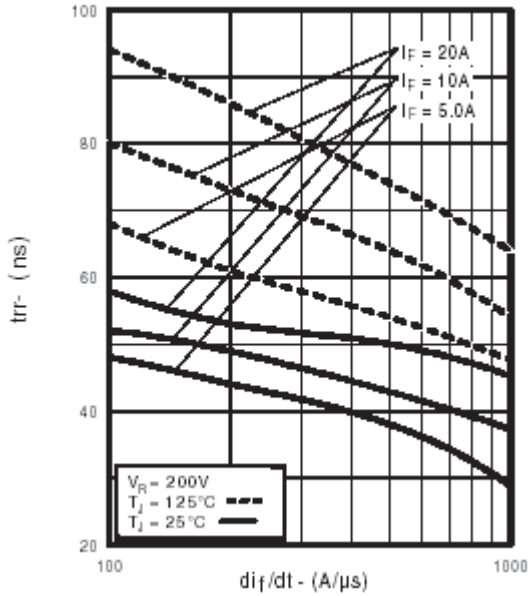

Fig. 14 - Typical Reverse Recovery vs. dI_F/dt

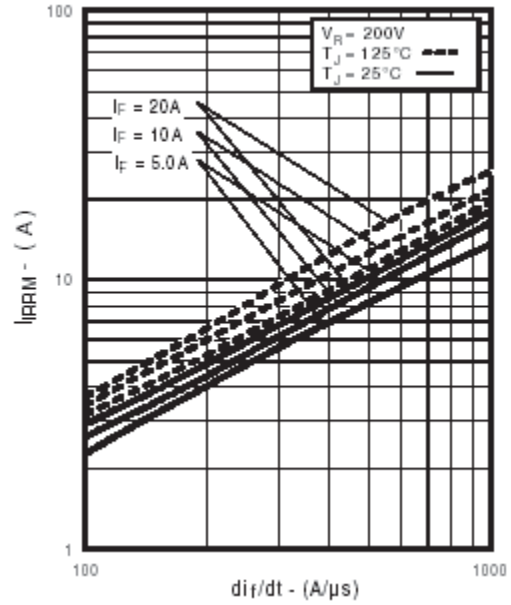

Fig. 15 - Typical Recovery Current vs. dI_F/dt

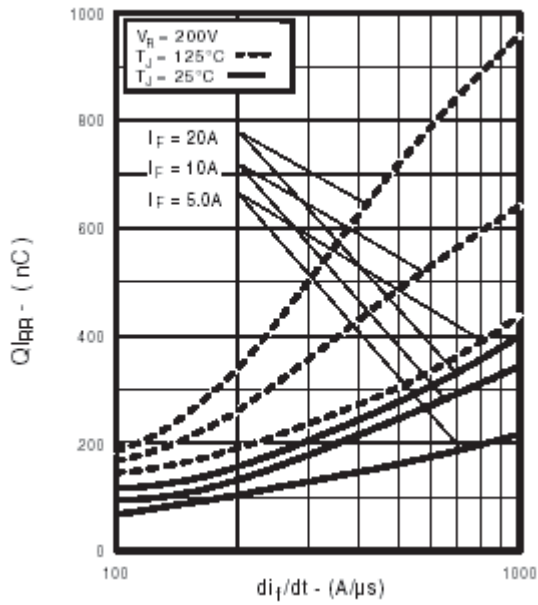

Fig. 16 - Typical Stored Charge vs. dI_F/dt
www.irf.com

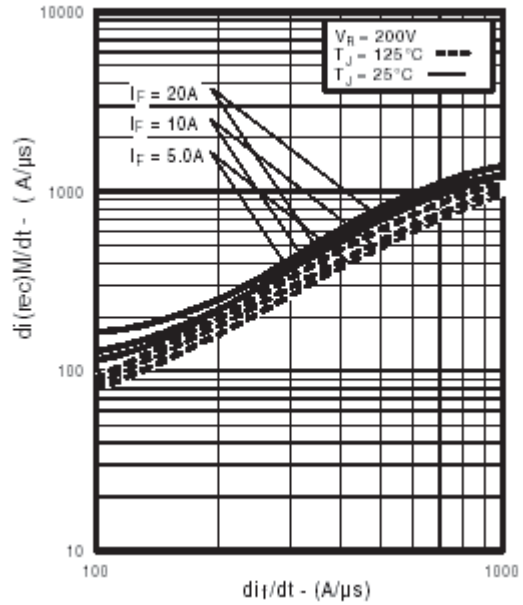

Fig. 17 - Typical $dI_{(rec)M}/dt$ vs. dI_F/dt

IRG4PH40UD2-EP

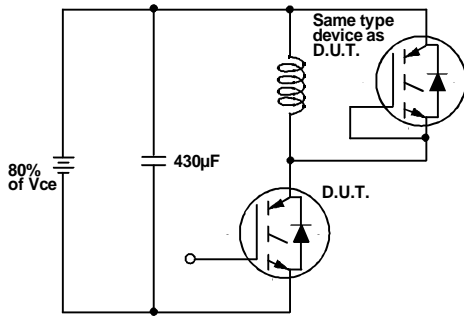

Fig. 18a - Test Circuit for Measurement of I_{LM} , E_{on} , $E_{off}(\text{diode})$, t_{rr} , Q_{rr} , I_{rr} , $t_{d(on)}$, t_r , $t_{d(off)}$, t_f

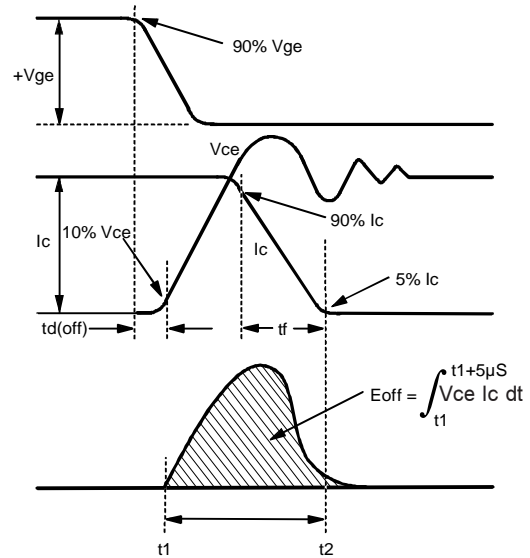

Fig. 18b - Test Waveforms for Circuit of Fig. 18a, Defining E_{off} , $t_{d(off)}$, t_f

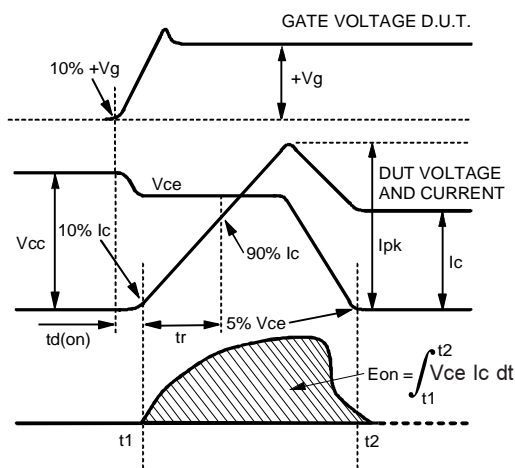

Fig. 18c - Test Waveforms for Circuit of Fig. 18a, Defining E_{on} , $t_{d(on)}$, t_r

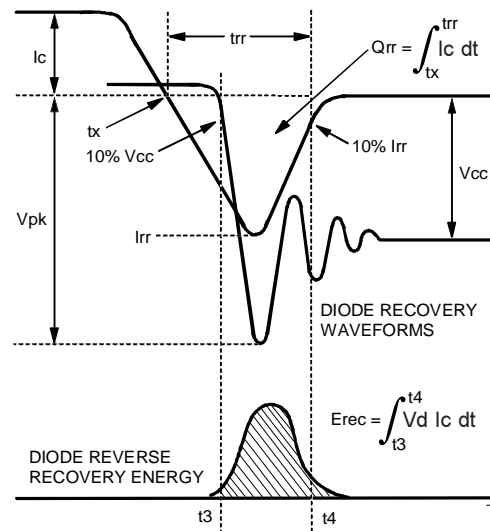

Fig. 18d - Test Waveforms for Circuit of Fig. 18a, Defining E_{rec} , t_{rr} , Q_{rr} , I_{rr}

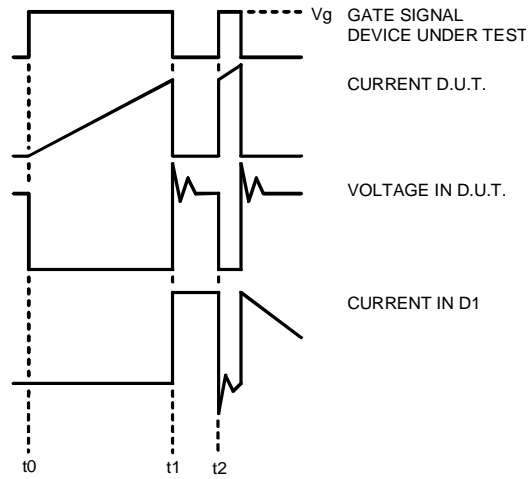

Figure 18e. Macro Waveforms for Figure 18a's Test Circuit

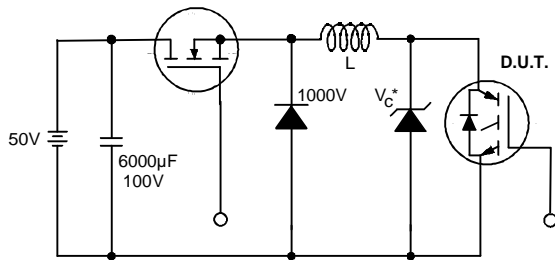

Figure 19. Clamped Inductive Load Test Circuit

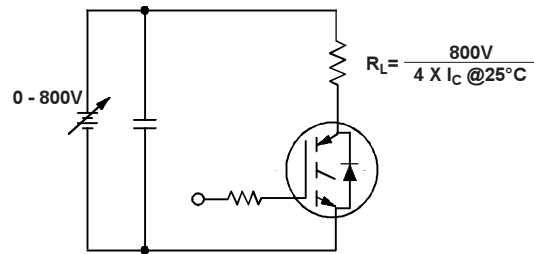

Figure 20. Pulsed Collector Current Test Circuit

IRG4PH40UD2-EP

TO-247AD Package Outline

International
IR Rectifier

Dimensions are shown in millimeters (inches)

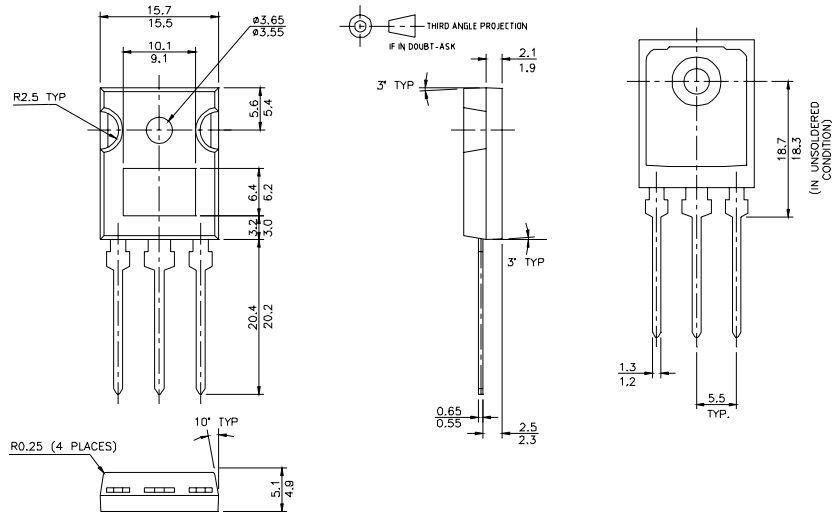

TO-247AD Part Marking Information

EXAMPLE: THIS IS AN IRGP30B120KD-E
WITH ASSEMBLY
LOT CODE 5657
ASSEMBLED ON WW 35, 2000
IN THE ASSEMBLY LINE "H"

Note: "P" in assembly line position
indicates "Lead-Free"

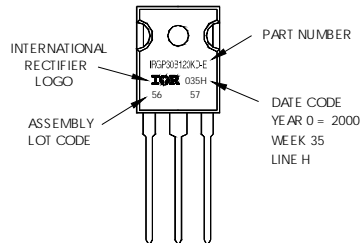

Notes:

- ① Repetitive rating: $V_{GE}=20V$; pulse width limited by maximum junction temperature (figure 20)
- ② $V_{CC}=80\%(V_{CES})$, $V_{GE}=20V$, $L=10\mu H$, $R_G=10\Omega$ (figure 19)
- ③ Pulse width $\leq 80\mu s$; duty factor $\leq 0.1\%$.
- ④ Pulse width $5.0\mu s$, single shot.

TO-247AD package is not recommended for Surface Mount Application.

Data and specifications subject to change without notice.
This product has been designed and qualified for Industrial market.
Qualification Standards can be found on IR's Web site.

International
IR Rectifier

IR WORLD HEADQUARTERS: 233 Kansas St., El Segundo, California 90245, USA Tel: (310) 252-7105
TAC Fax: (310) 252-7903

Visit us at www.irf.com for sales contact information. 07/04
www.irf.com

Note: For the most current drawings please refer to the IR website at:
<http://www.irf.com/package/>